

THE TRIDI PANEL IS A PREFABRICATED PANEL

This extremely strong structural product consists of a super-insulated core of rigid expanded polystyrene sandwiched between two-engineered sheets of eleven-gauge steel welded wire fabric mesh. To complete the panel form process a nine-gauge steel truss wire is pierced completely through the polystyrene core at off set angles for superior strength, then welded to each of the outer layer sheets of eleven-gauge steel welded wire fabric mesh. These three elements are joined by EVG state of the art manufacturing equipment producing a THREE-DIMENSIONAL lightweight panel that due to its characteristics makes it one of the strongest building materials you can find.



TRIDIPANEL CORE DENSITY AND STEEL MESH STYLES

Dimensions of the panels are manufactured from a starting width of 4' x 8' lengths. The panels can be prefabricated up to (40' in length) in (8" increments). Wire gauges available are 11, 12.5 and 14 and may be ordered in bright or galvanized metal.

POLYSTYRENE CORE THICKNESS	OUTER LAYER Wire MESH TO MESH
1.5"	2.5"
2.0"	3.0"
2.5"	3.5"
3.0"	4.0"
3.5"	4.5"
4.0"	5.0"
4.5"	5.5"
5.0"	6.0"

“Hadrian Tridi-Systems” Assembly Manuel

Index page

1. Materials used in the “Hadrian Tridi-Systems”
2. Tools recommended for assembling and safty
3. Foundations preparation
4. Panel preparations and assembly for, walls, doors, electrical, plumbing, columns, beams, and arches.
5. Panel preparation and assembly for roof, and floor
6. Application of concrete and finish to panels.

Materials used in the Hadrian Tridi-systems

1. Tridi panels 4’x8’ through 40 ft.
2. Out side corner mesh
3. Inside corner mesh
4. Flat supplies mesh
5. End cap mesh
6. Rebar
7. Concrete
8. Pressure treated lumber

Tools recommended for assembling

1. Tape measure
2. Level
3. Skill saw and diamond blade, reciprocating saw
4. Pneumatic wire fastening tool
5. Bold cutters
6. Braces
7. Cement and Stucco tools

Foundations preparation

1. Setting rebar in concrete foundation
2. Setting key way in concrete foundation

Panel preparations and assembly

1. Walls,
2. Doors,
3. Electrical,
4. Plumbing,
5. Columns,
6. Beams,
7. Arches.
8. Roofs and second floors

Application of concrete and finish

1. Hand application
2. Machine applications

Hadrian Tridi-System

Basic Tools



Skilsaw

With diamond edge masonry blade is used to easily cut doors and windows in panels



Power washer can be used to trim back polystyrene foam cleanly neatly.



Propane Torch

The Propane torch trims back the polystyrene foam cleanly and neatly for installation of rebar, electrical conduit, and plumbing installations.



Pneumatic Wire Fastener

Pneumatic wire fastener can easily connect corners, end cap, and flat splice mesh to panel



Brasses are used to hold panels in place during cement application.

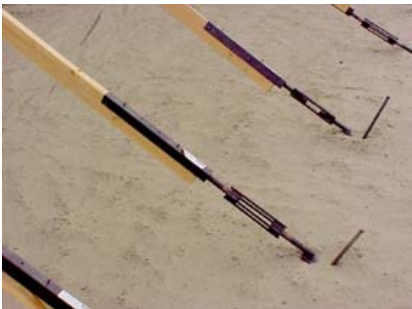

Adjusters were added to brasses.

Basic Hand Tools

1. Precipitating saw
2. Hand level
3. Bolt cutter
4. Pliers and
5. Wire cutters
6. Tape measure



Materials used in Hadrian Tridi system

1. Tridipanel 4'x 8' through 40 ft.
2. Out side corner mesh
3. Inside corner mesh
4. Flat slice mesh
5. End cap mash
6. Rebar and wire ties
7. Concrete



#1

Pressure treated lumber



#2

Safety first

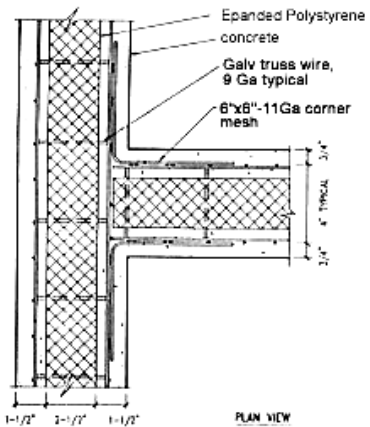

#3



#4

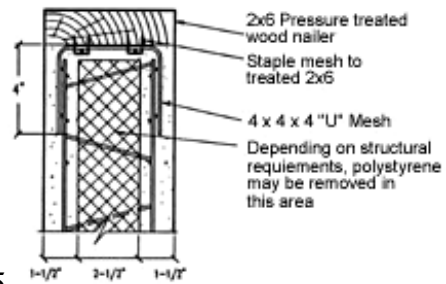

#5

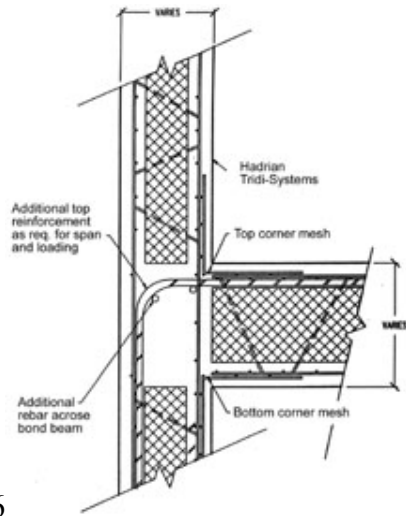

#6

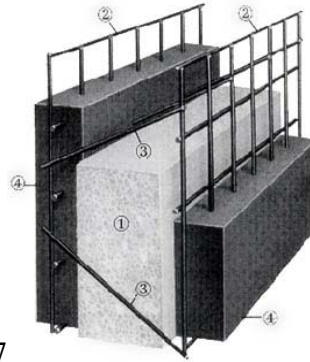

#7

Foundation preparation for Tridi-panel sys.



Foundation

The foundation used for Hadrian Tridi systems are very similar to the traditional foundation. Plans will specify that metal anchors be placed in the wall footing or slab to secure the panel bases. Lengths of straight rebar extending perpendicular from the concrete are commonly used for this purpose.

Care must be taken to insure that a proper line, and spacing of these anchors are maintained the panels should be placed so that the rebar is set between the mesh and the polystyrene. This arrangement provides easy wall alignment.

Key ways and Wall anchors

A key way may be installed in concrete slab using a board to be removed when concrete cures along with rebar and tie-down straps to secure panels to concrete slab. To compliance with engineers specifications and local codes

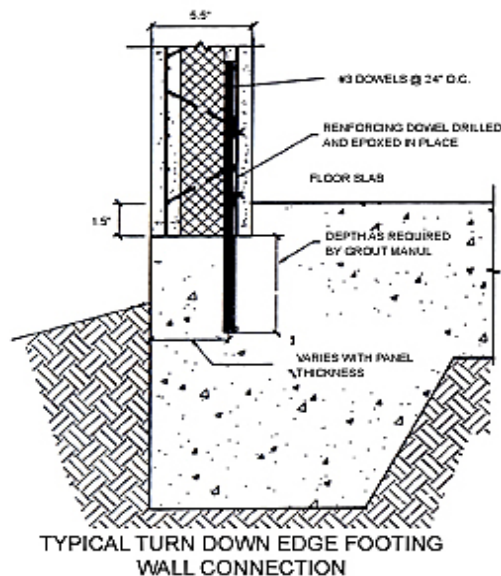

Installing rebar

Concrete was drilled using mason bit. Hole was filled with epoxy cement. Rebar is pressed into hole rebar and panels can also be set into wet concrete.



Hadrian Tridi Systems

Preparation and Assembly



The rebar is embedded within the concrete slab. The panel is placed over the rebar, through the open space between the polystyrene core and the wire mesh. Once set, the rebar is fastened directly to the wire mesh with tie wires. It is critical the rebar be installed in a straight line so the rebar fits easily into the cavity between the polystyrene and the wire mesh. It is important to make sure the rebar is completely exposed so it becomes monolithically enclosed with the cement application. Should the building department or engineer require additional tie downs, the polystyrene core can be removed from the base of the panel. The panel is then set in place over the required tie-down and cemented in place. Another option for placing the rebar in the concrete slab is to drill the concrete slab and pour epoxy in the cavity placing the rebar within its confines. Typically, the spacing of the rebar is (24") on center.



Braces are used to support panels during construction

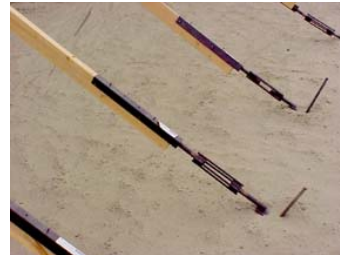

Optional brace adjusters were added to braces



The window and door openings may be cut out with the use of these primary tools.

1. Skilsaw with diamond edged masonry blade,
2. Reciprocating saw or,
3. Pneumatic cutter,
4. Small hand saw to remove the polystyrene.

It is recommended that caulking sealant compatible with polystyrene be used to seal jams to panels.



For residential construction wood casings made of pressure treated timber 1 are fitted into the openings. The windows and doors jams are then fastened to the treated casing.

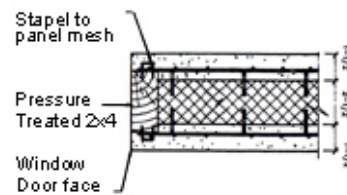

Metal window & door details

Steel door jams may be cemented into the wall. This method is normally used in commercial construction.

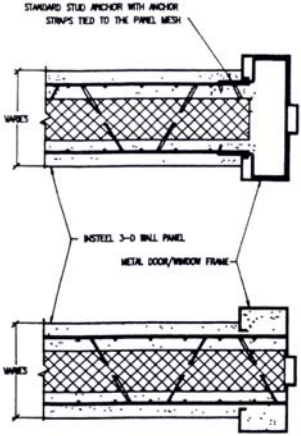

DETAILS ILLUSTRATE STANDARD 3-0 PANEL CONFIGURATION
ACTUAL PANEL DESIGN MAY VARY

Hadrian Tridi System Splicing panels and corners



Outside corner wire mesh is easily placed over panel corners to secure panels and ensure a strong corner. Wire ties or pneumatic fastener is used to secure corner mesh two panels



Inside wire corner mesh is also installed using the same methods as used for outside corner.



Flat 2"x2" wire mesh strips are used to splice panels together. The strips are easily attached to the panels using the pneumatic fastener. Be sure that these mesh strips fit close against the panel mesh. Strips of cover mesh are usually placed diagonally above and below window and doors openings and on both sides to prevent corner cracks from developing in concrete finish.



Pneumatic fastener is being used to attach flat wire mesh to panel seams.

Hadrian Tridi-Systems Columns and Beams

Bond beams and columns may be located anywhere within the Tridi panel system. The panels are cemented on one side of the panel. Then removal of the polystyrene from the opposite side of the wall where the beam or column is required. Rebar is added to the cavity and tied in place. Cement is then applied to the second side of the panels filling the cavities and rebar with cement creating a bond beam or column.

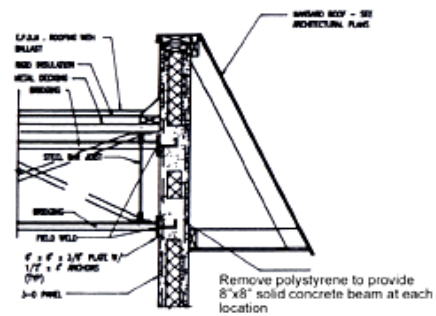

Hadrian Tridi Systems

Roof & Second Floor



Tridi-panels are so strong they easily hold roof trusses and sheeting prior to cement and finish.

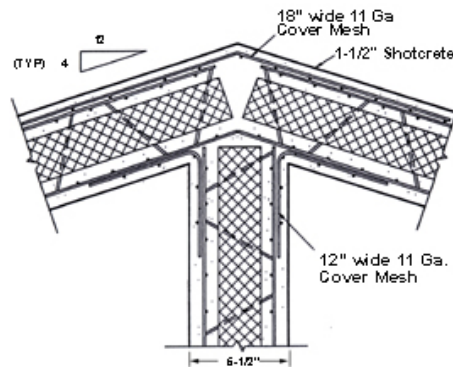
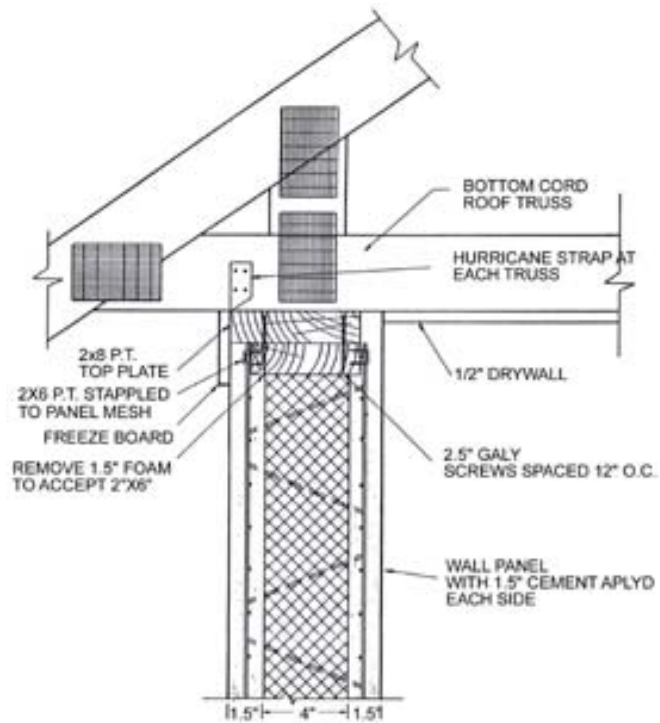

Standard details typical wall and roof ridge connection.



Additional rebar has been added to the panels providing additional strength to second floor.

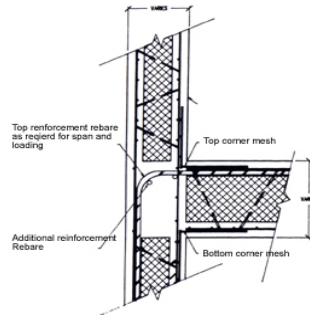

Hadrian Tridi-Systems

Electrical and Plumbing

The installation of electrical or plumbing is achieved by removing the polystyrene core to create a cavity so that electrical conduit or plumbing may be installed. The wire mesh is approximately 3/4 inch off the polystyrene so you have a space to install electrical and plumbing. If this opening needs to be larger, the polystyrene core can be removed with a small keyhole saw or butane torch. The polystyrene will not burn it will shrink or melt leaving a cavity. The electrical or plumbing is then installed into the cavity.

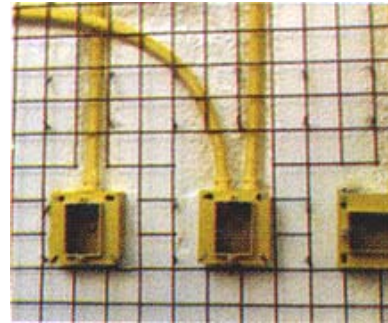

**THE POLYSTYRENE WILL NOT BURN
IT WILL SHRINK OR MELT
LEAVING A CAVITY.**

Hadrian Tridi Systems

Application of Cement, and Stucco



The Portland cement is applied either by hand or machine application on both sides of the panel. This part of the operation is very specialized. We recommend a licensed plastering contractor for this part of the operation. For architects with a special finish in mind we would like to mention that the architectural foam molds or metal trim could be incorporated into your design to achieve the desired finish. A few of the above-mentioned might be fry regrets, point-to-point reveals, parting screed etc. The versatility of numerous

types of plaster finishes or stucco finishes will work on interior and or exterior walls. For superior strength and accelerated schedules we recommend Rapid Set Eisenwall Cement Products. Almost any type of finish your imagination can conceive will work such as stucco finishes, brick, mini-brick, stone, stone facing tile and any other product that can be applied to cement.

**Billy
Shooting cement
On to
Tridi panel**

**This part of the operation
is very specialized.**



**We recommend a licensed
plastering contractor for
this part of the operation.**